



# PORTA GANTRY 5000™

➤ Assembly & Operation Guide



**Correct Operation 4**

- Intended Use
- Inspection Prior to Initial Operation
- Inspection Before Starting Work
- Maximum Capacity
- Temperature Range
- Notes for Correct Operation
- Warning
- Traversing the Load
- Moving under Load
- Fall Protection
- Additional Notes for Correct Operation
- Warning
- IRATA

**Inspection & Maintenance 9**

- Regular Inspections
- Maintenance & Repair
- Storage & Transportation

**ATEX 10**

- ATEX
- Classification [Zone 2]
- Spark Formation
- Static Electricity
- Inspection, Maintenance & Repair

**Assembly Instructions 12**

**Variants & Options 21**

**Dimensions 26**

**Quality & Safety 28**

- Regulations
- Accreditations
- Conformité Européenne [CE] & UK Conformity Assessed [UKCA]
- Testing
- Language
- Product IPR

**Product Labelling 30**

**Inspection Record 31**

# Lightweight. Portable. **Safe.**

Please read the following instructions and guidance notes carefully, before using or operating the system.

They contain important information about how to handle and use the system in a safe and efficient way, avoiding danger, reducing repair costs and downtime, and increasing the reliability and lifespan of the system.

They apply for:

- Operation, including preparation, troubleshooting during operation and cleaning
- Maintenance, inspection, repair
- Transportation

It is the responsibility of the end user to adhere to the Health & Safety and accident prevention standards and legislation valid in their respective countries and any regions in which the system is being used. It is also incumbent on the user or competent person to ensure that anyone working with the equipment has the necessary medical and physical capabilities. A rescue plan also needs to be in place in the event of an emergency that could occur during the work. This document should form part of the overriding Risk Assessment and Method Statement required for each lift.

## Intended Use

This product is intended to be used for the lifting of goods, the lifting of personnel, rope access or for providing a safety anchor for the prevention of falls.

It is expected that all users of this product have the necessary medical and physical capabilities, are fully trained and competent in its safe assembly and use.

## Inspection Prior to Initial Operation

This product must be inspected prior to initial operation by a competent person to ensure that the structure is safe and that it has not been damaged by incorrect assembly, transport or storage.

## Inspection Before Starting Work

Before starting work, the assembly of the product and all load-bearing components should be checked for visual defects. This includes checking the integrity of all profiles for denting, making sure there is no wear or elongation on the bolt holes and ensuring that the trolley moves freely along the beam.

## Maximum Capacity

**Goods Lifting:** This product is designed to lift and lower loads up to its rated capacity. Do not exceed the working load limit indicated on the product.

**Personnel Lifting:** When lifting people, the overall load limit is reduced by half to provide an increased safety factor. The maximum capacity

permitted by the personnel winch/accessory used in conjunction with this product also needs to be considered.

## Temperature Range

This product can be operated in ambient dry temperatures between -20°C and +55°C (-4°F and 131°F). Consult your supplier in case of extreme working conditions. If used in sub-zero and wet conditions, fall arrest appliances characteristics may change.

## Notes for Correct Operation

- Assemble only as instructed (ensure all bolts are present and fitted correctly as per instructions)
- Suitable, appropriately rated winches and connection plates must be used for all applications
- The product should be set up at a safe distance from the hazard or lift area, before moving the structure into place
- The supporting ground/structure where the gantry is to be used must be stable and capable of withstanding the maximum expected load applied during use
- We recommend that gloves are worn when using the equipment
- The beam must be horizontal prior to any lift and A-Frames vertical and parallel to each other

- Do not use the product if the trolley does not run freely along the beam. (For certain applications, such as when the system is being used as a restraint point, the trolleys can be locked into position)
- Attach the hoist to the lifting point on the trolley only, making sure it is attached in a way that does not expose the user to danger by the hoist, chain or load
- Only raise and lower loads when castor brakes are engaged
- Do not allow the load to swing
- To avoid side pull, lowering and lifting should only be carried out when the load chain forms a straight and vertical line between the load and lifting attachment point on the trolley (refer to figure A)

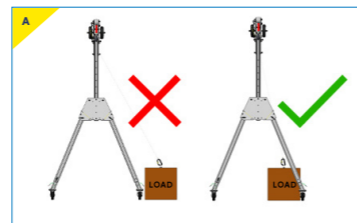

- We recommend the use of load-sensing or overload protection devices on all lifts
- The risk assessment and method statement

must take into account any factors that might apply additional loading to the system during lifting operations

- Take care when transporting and storing the system to avoid damage
- To ensure stability of the structure, the operating span of the beam must be equal to or greater than the distance between the castors on the A-Frame

## Warning

- The equipment should not be used outside of its limitations, or for any purpose other than that for which it is intended
- Do not lift or transport loads while personnel are in the danger zone
- Do not allow personnel to pass under a suspended load
- Never leave a suspended load unattended
- Do not start moving the load along the beam until you have checked that it has been attached correctly
- Don't allow the load to hit the system frame
- When winching, only use one winch with each sheave and make sure they never cross paths with each other
- Be aware of any adverse weather conditions such as strong or gusty winds which could impose additional horizontal loads and affect the stability of the structure. Stop using if

weather is impacting on lifting, and either disassemble the gantry or tie it to a rigid structure to ensure it can't overturn

- Be aware of hazards when setting up/folding down, such as trapping fingers in rotating parts

## Traversing the Load

Due to a high modulus of elasticity in aluminium, when loaded the gantry beams will deflect. This is perfectly normal for our products. Using aluminium enables us to achieve the highest levels of strength to weight ratio, which is an important feature of portable gantries. The level of deflection will be determined by the span length and the beam profile that is being used, as well as the weight of the load being lifted.

Before traversing loads on the PORTAGANTRY, it is important to take in to account the following;

- Only use appropriate REID trolleys to move the load on the beam.
- When moving a loaded trolley along the beam, move the load steadily and in a controlled manner. Do not apply an excessive force to try and move the load if it does not move easily.
- Depending upon the beam section (A, B or D), beams will deflect when loaded. **This is normal.** The greater the load, the greater the deflection. Please refer to our beam deflection

table for more information. Deflection must be taken into consideration when planning the lift.

- Any traversing of loads along the beam must be performed in a controlled manner to ensure complete stability of the structure throughout the operation.
- Deflection of the PORTAGANTRY can be reduced (or limited) by increasing or down rating its working load limit (WLL) by 50%. Increasing the beam section can also help limit deflection. Please contact REID for further advice.
- Another safe recommendation for moving the load along the beam is to use a mechanical aid. REID Lifting can supply you with our geared trolleys or rope control systems. The rope control system is particularly useful on longer beams or where the gantry is at maximum height of lift.
- Using a mechanical aid such as a geared trolley, chain hoist in conjunction with shackled cheek plates or rope control system for traversing the load helps optimise the gantry capacity.

The Trolley Rope Control system has the added advantage of enabling the operator to control the movement of the trolley from a safe location at the side of the gantry. The system includes a winch and series of sheaves that produce a mechanical advantage and reduce the effort during operation.

For guidance we recommend the maximum loads that can be safely moved with standard trolleys without a mechanical aid (subject to all other site conditions being taken into consideration in a risk/hazard analysis) are:

- A section beams up to 4570mm = <500kg or 50% capacity of the gantry whichever is lower
- B section beams up to 5500mm = <500kg or 50% capacity of the gantry whichever is lower
- D section beams up to 5500mm = <1000kg or 50% capacity of the gantry whichever is lower
- D section beams up to 8400mm = <500kg or 50% capacity of gantry whichever is lower

To be able to effectively and safely move loads above these limits the operator should use the most appropriate mechanical aid. For further advice, please contact REID Lifting or a qualified or competent person.

**Incorrect use of the gantry could lead to accidents causing personal injury and/ or damage to equipment and infrastructure. Please ensure that the advice and guidelines in this Assembly & Operation Guide are followed**

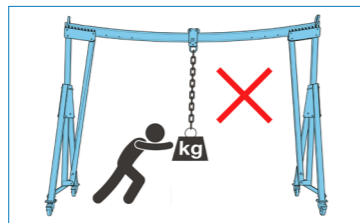
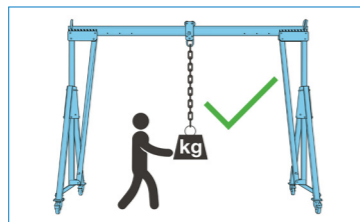

## Moving under Load

When moving the gantry underload, the following instructions MUST be followed:

- This product can only be moved in the direction perpendicular to the beam
- Directional locks must be used on the castors (perpendicular to the beam only)
- The end user MUST make sure the center of gravity of the load is known and the lifting points are in such a way that the load is EQUALLY distributed, so the load generates a vertical pull to the beam.
- The load is not allowed to swing
- The floor must be smooth, flat, free from cracks or steps and the weather conditions should be safe for the operation (i.e. not when frost, ice or snow present)
- A risk assessment and method statement are required to be completed by a competent person before moving the gantry under load
- The gantry's movement must be controlled at a slow speed, no sudden movements or high speeds are allowed.

## Fall Protection

When being used as part of a fall protection system the user must use a body harness and retractable device or shock absorber to EN355 that limits the maximum allowed force (M.A.F.) to 6kN. Winches used with the system should comply to EN1496:2017 or equivalent.

In the event of simultaneous goods and personnel combined lifting/ fall arrest or when being used as a fall arrest system in sub-zero and wet conditions contact the supplier as capacities may be reduced.

Only one person should be attached to each trolley in accordance with the notified working load limit (WLL). Each lift must be properly planned, and all weights clearly known along with the WLL and constraints of all personal fall arrest system components.

The capabilities stated in the table apply to standard range systems only. If unsure about your system consult serial labels, information filled in on page 31 or consult your supplier. Bespoke versions of the system are available tailored to specific lifting needs. These versions are designated with a 'C' at the end the product number on the serial label attached to each A-Frame and beam.

For custom designed gantries please contact your supplier for appropriate rating and capabilities.

This product has different ratings depending upon the application as detailed in the table below:

Application	Capacity
Goods [kg]	5000
Fall Arrest*	5 persons
Personnel [kg]	2500

\*Only Applicable to PORTAGANTRY systems being used in accordance with PD CEN/TS 16415:2013. When being used in accordance with EN795:2012, the structure shall be limited to a maximum of one user in fall arrest.



The system is not suitable for fall arrest applications.



The system is suitable for fall arrest applications. Specify number of users. Max weight of 150kg.

## Additional Notes for Correct Operation

- The anchorage must always be above the users head to prevent dangerous free falls
- Always carry out pre-use checks before using this equipment. It is advised to use a buddy system and inspection must be by a competent person.
- The fall arrest device must only be attached to the lifting point on the trolley or the designated location on the cheek plate or upright. (see product images and set up instructions).
- Only use the product for fall arrest applications when the castor brakes are engaged.
- To ensure stability of the structure, the operating span of the beam must be equal to or greater than the distance between the castors on the A-Frames
- Never walk away from the footprint of the product or move outside designated safe zones whilst connected to it where there is a risk of a fall. Ensure that the operating area is within the footprint of the system before beginning work.
- If the product has been subjected to a fall arrest or impact force it must be immediately removed from service.

Standard Beam Length [mm]

WLL [kg]	2500	3000	3920	4570	5500	6000	8400	9000
5000	D 5-10mm	D 10-15mm	D 20-30mm	D 30-40mm	D 50-60mm	X	X	X

Approx Beam Deflection at Max Capacity [mm]

## ➤ Correct Operation

- When using the product as a fall arrest anchor ensure there is adequate fall clearance when working at height (figure B). A competent person should calculate this taking into account all of the components of the personal fall arrest system and allowing a safety margin.

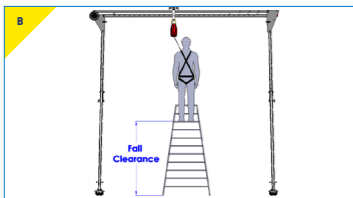

- Only use the product for fall arrest applications when the castor brakes are engaged.
- Always consider the potential effects of sharp edges, chemical reagents, electrical conductivity, cutting, abrasion, climatic exposure on all components of the fall protection system, and the effect of offset forces as a result of pendulum falls.
- Ensure the structure on which the product is mounted is horizontal. If necessary, adjust the products feet to achieve a level operating structure.

- The substrate of the structure on which the product is placed must be able to sustain the loads specified for the device in all orientations permitted, including a safety factor of at least 2.
- Never exceed the number of allowable users.
- Never adjust the product whilst a person is attached to it.
- Only use designated anchor points for the attachment of fall protection devices
- Ensure that any fall protection system components being used are compatible and meet the requirements of applicable standards
- When using this equipment ensure that there is a rescue plan prior to starting work and ensure that users are trained in the correct execution of the plan and have all necessary rescue equipment to hand
- Where required by regulation, each installation must be approved by a qualified person
- Always wear appropriate PPE when installing, setting up, dismantling and using this equipment.
- Misuse of this product could result in serious injury or death

### Warning

- When using for fall protection, only use one lifeline with each trolley/sheave and make sure they never cross paths with each other
- If more than one person is attached to the gantry, make sure that working procedures prevent individual lifelines from crossing and becoming tangled
- When using the product in conjunction with another manufacturer's fall protection products, ensure that you have read the instructions for use of those product to ensure their suitability and any restrictions for use.
- It is not recommended to mix the use of the gantry with personnel and goods lifting simultaneously.
- It is essential for safety that the product is withdrawn from use immediately and not be used again until confirmed in writing by a competent person should,
  1. Any doubt arises about its condition for safe use or;
  2. It has been used to arrest a fall

### IRATA

This product is suitable for rope access and has been tested to 15kN. Static load as per test requirements of IRATA international code of practice (ICOP).

## ➤ Inspection & Maintenance

The following information is based on REID Lifting's recommendations and does not remove the responsibility of the user to comply with the relevant regulations and standards that are valid in the respective countries and regions where the system is being used.

### Regular Inspections

To ensure that the product's frame remains in safe working order it must be inspected regularly by a competent person. We recommend inspections every 6 months for personnel lifting and every 12 months for goods only, unless adverse working conditions or profile of use dictate shorter periods. The components of the system frame need to be checked for damage, wear, corrosion or other irregularities. It may be necessary to disassemble the system frame in order to do this. Particular attention should be paid to checking the profiles for denting, making sure there is no wear or elongation on the bolt holes and ensuring that the trolley moves freely along the beam.

Any necessary repairs should only be carried out by an approved specialist workshop using original spare parts. It is recommended that once inspected or repaired, the device is marked with the date of the next inspection.

Inspections are instigated by the user. If detailed information is required on inspection and test criteria, please refer to your supplier's technical department. The equipment Inspection Record is on page 31.

If using the product in explosive atmospheres, see additional section titled ATEX.

### Maintenance & Repair

In order to ensure correct operation, the conditions for inspection and maintenance must be complied with. If any defects are found, stop using the product immediately.

No alterations or additions to the equipment should be made without the written consent of the manufacturer. Any repair must be carried out in accordance with the manufacturer's procedures.

It is recommended to maintain the equipment in a clean and dry manner. Cleaning is suggested using a sponge or cloth with warm, soapy water, rinsing and allowing to dry.

### Storage & Transportation

When transporting the components, take note of all the manual handling considerations.

Do not throw the product down or stack any items on top of it.

Always place carefully and securely on the ground to avoid damaging the equipment.

**ATEX**

This product has been designed for use in explosive atmospheres in line with the following requirements and information. Any use which differs or exceeds this is considered incorrect and REID Lifting Ltd will not accept any responsibility or liability for damages resulting from false application. The risk is solely with the user. If the product has been customised in any way, then it may not comply with standards and no longer be suitable for use in explosive atmospheres. If this is the case, then the product will not have any of the markings below. If in doubt, please contact your REID representative.

**Classification [Zone 2]**

As standard, the product meets the requirements of Category 3 equipment for use in Zone 2 explosive atmospheres, providing a normal level of protection where mixtures of air and gases, vapours or mists or by air and dusts mixtures are unlikely to occur or, if they do occur, are likely to do so only infrequently and for a short period only.

The product will have the following identification on the serial label:

**As Standard for Zone 2 Environments:**

Ex II 3 GD  
 Ex h IIC T6 Gc  
 Ex h IIIC T85°C Dc  
 Tamb -20°C to +55°C



**Spark Formation**

There is an increased danger of ignition when certain material pairings clash, namely non-corrosion-resistant steel or cast iron against aluminium, magnesium or pertinent alloys. This applies especially in the case of rust or surface rust. When assembling the product and inserting fastening components, these must therefore be clear of rust and debris of any kind. As stated previously, care must be taken to ensure the gantry is handled in a suitable manner, never thrown down and always placed carefully onto the ground.

- For Zone 2 applications, the height of the system should not be adjusted using the ratchet mechanism and/or geared wheel within those zones
- REID recommends the use of corrosion resistant tools when assembling this system to prevent the possibility of any sparks.

**Static Electricity**

For Zone 2 applications, there is a potential risk of static electricity build-up leading to an incentive spark. Although the risk of such ignition is unlikely, the system must be earthed during assembly and use. This can be achieved by attaching an earthing lead to a convenient location on metallic parts of both the system and trolley.

**Inspection, Maintenance & Repair**

Special attention should be given to dust deposits on the structure, especially in areas where the profiles come into contact, and should be wiped clean and care taken not to apply materials that could create electrostatic charging. Additionally, the bearings in the trolley rollers and castors should be checked to ensure they rotate freely.

The structure is predominantly constructed from aluminium which will not rust. However, there are steel components used throughout. These are; fasteners, castors, master-link, trolley rollers, A-frame height adjustment gearing system (if fitted) and the height adjustment ratchet (if fitted).

Where there is sign of any rust deposits on the aluminum structure, it should be wiped clean as above and, where there is sign of rust on a steel component, that component should be removed from use and the structure not used until a replacement is fitted.

If using the product in explosive atmospheres, in addition to the Regular Inspection and Maintenance information above, these additional instructions should be followed:

- Inspections must be instigated by the user prior to each use if used in a potentially explosive atmosphere.
- Inspections and maintenance must be carried out at a safe distance away from an explosive atmosphere.

# Assembly Instructions

The PORTA GANTRY and its constituent components are described in the image below.



Appropriate PPE should be worn: > Hard Hat > Protective Footwear > Gloves

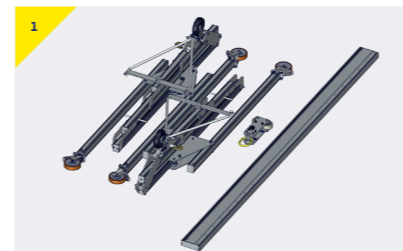

The PORTA GANTRY system is delivered flat packed on a pallet and should include:

- > 2 x A-Frames
- > 1 Trolley
- > (Stabiliser legs – Option)
- > Beam (sometimes shipped separately)



Gantry Tool Set (supplied as an option):

- > Ratchet handle 1/2" sq drive
- > 24mm socket
- > 24mm combination spanner
- > 14mm long series allen key
- > 14mm Hex key socket

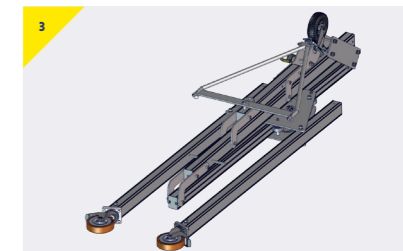

This illustration demonstrates how an A-frame will arrive, prior to its assembly.



Assemble each A-Frame by:

- > Positioning legs and bolt in place



> Attaching leg brace

The unit is most easily assembled with the A-Frames at their lowest height setting and this is the recommended position to start from. (A-Frame shown with Geared elevation and Stabiliser leg attached)



- > Apply the castor brakes
- > Put brakes on only with protective footwear ensuring that the castors are in the orientation shown

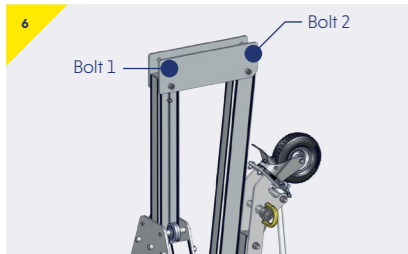

This illustration demonstrates the bolt positions (1 & 2) for the cheek plates.

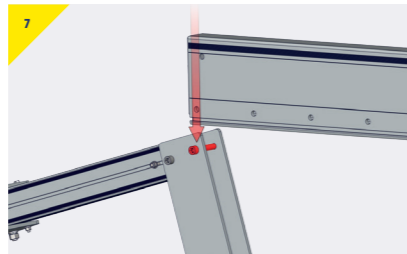

- Lay the two A-Frames a beam length apart on a flat surface in line with each other with the castor wheels outward and brakes on
- Lay the beam on the A-Frames, resting on bolt 1 on each cheek plate

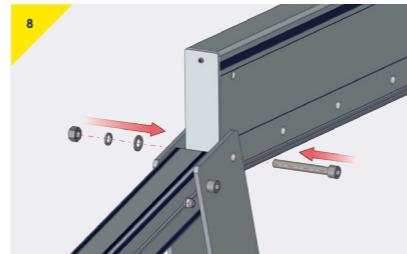

- Offer one end of the beam to the rear bolt-hole on the cheek-plate (bolt 1) and insert a bolt
- Put on plain washer, spring washer then nut, finger tight

## Mechanical Aid Assembly

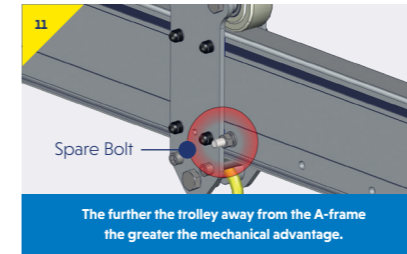

The further the trolley away from the A-frame the greater the mechanical advantage.

- Move the trolley to the last beam hole on the side of the A-frame to be assembled
- Insert the spare bolt into the beam, between trolley and A-frame to be assembled, as shown
- Fasten the bolt with the nut to ensure it does not remove itself

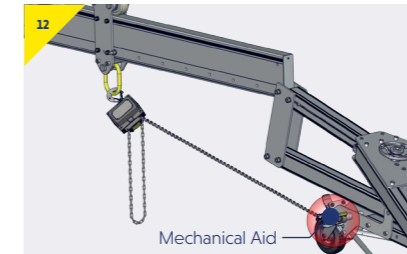

- Attach chain block to trolley master-link and attach the lifting chain to the mechanical aid, as shown

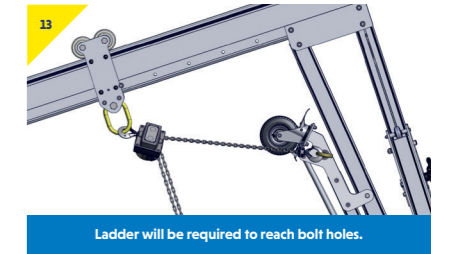

Ladder will be required to reach bolt holes.

- Operate the chain block until the A-frame assembly is perpendicular to the beam and assembly bolt holes in cheek plate

8a The gantry beam has adjustment holes to narrow the footprint of the gantry. This is best done when the gantry is assembled with 2 persons sliding the A-frame inwards while 1-2 persons steady the gantry by holding the beam – this will require the use of a step ladder. If this process is required to be carried out often then an upgrade to 'lobed cheek plates' can be purchased which allows the gantry to be assembled as steps 8-20 but with one A-frame inward from the end of the beam.

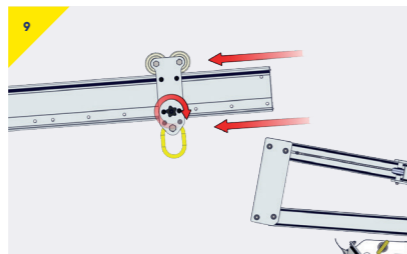

- Thread the beam trolley over the other end of the beam and lock with the friction brake at approximately centre position. If using a gated trolley, lock with the friction break

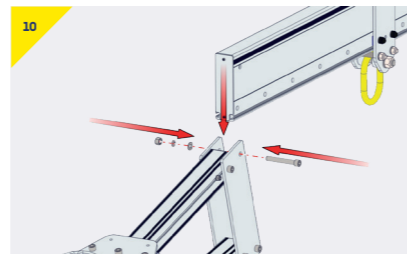

- Offer opposite side of beam to the rear bolt-hole on the cheek-plate (bolt 1) and insert bolt
- Put on plain washer, spring washer then nut, finger tight

13a Tighten both bolts until the spring washer is fully depressed

- Slacken chain block and remove bolt restraining the trolley
- Move trolley to other end of beam and repeat steps 11-13 for second A-frame assembly. Then follow step 20



# ➤ Assembly Instructions

## Manual Assembly

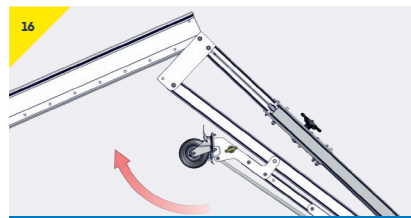

Be careful not to trap any fingers in this operation.

If mechanical aid assembly not possible proceed as follows:

- Secure trolley at opposite end of beam to be assembled and secure by tightening the trolley knob



For additional safety, a spare bolt can be temporarily placed in the adjustment point.

- Move trolley to other end of beam, opposite to the end to be raised, and secure by tightening the trolley knob

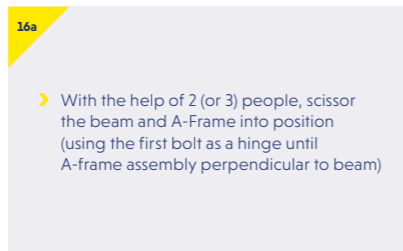

- With the help of 2 (or 3) people, scissor the beam and A-Frame into position (using the first bolt as a hinge until A-frame assembly perpendicular to beam)

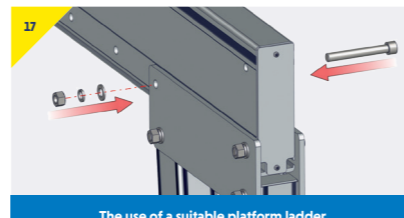

The use of a suitable platform ladder may be required to reach the bolt-hole.

- Insert the second bolt into the cheek-plate. Tighten both bolts until spring washer is fully depressed, be cautious not to overtighten

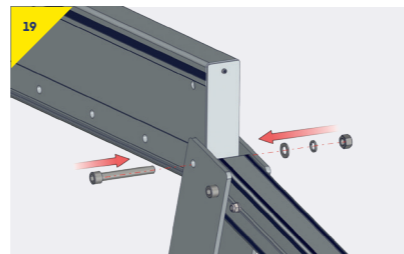

- Insert and tighten the final beam bolt

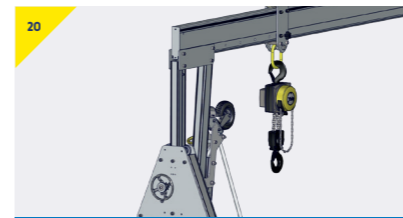

The use of a suitable platform ladder may be required.

- If the hoist is not already attached to the suspension point on the trolley, do so now
- If this is not safe, disassemble the gantry and re-start adding the hoist prior to scissoring the A-Frames

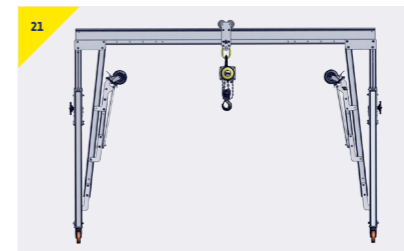

The gantry is now erect at its lowest height setting.

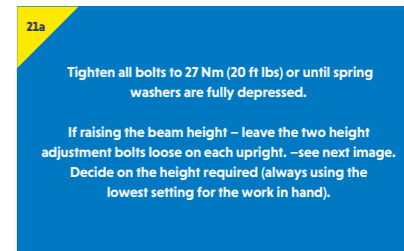

Tighten all bolts to 27 Nm (20 ft lbs) or until spring washers are fully depressed.

If raising the beam height – leave the two height adjustment bolts loose on each upright. –see next image. Decide on the height required (always using the lowest setting for the work in hand).

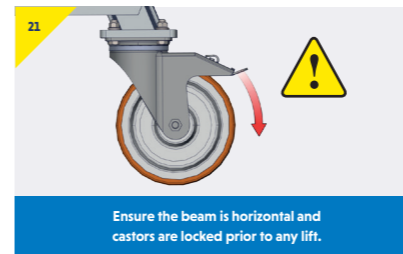

Ensure the beam is horizontal and castors are locked prior to any lift.

- Release trolley brake and castor brakes to position the gantry over the load ensuring, when possible, that the load is lifted from the centre of the beam

# ➤ Beam Height Adjustment

## With Geared Handwheel

Two person operation recommended – one on each A-Frame

Always wear gloves when using this item.

For taller A-Frames a suitable platform ladder should be used to operate the gearwheel at an ergonomic height.

The following steps should be done concurrently on each A-Frame, ensuring that the gantry uprights are vertical, and the beam is horizontal.

- Ensure the castor brakes are engaged
- Hold the gear wheel securely
- Remove the 2 upright bolts, as shown in figure 1
- Compress center pad with thumbs whilst holding the wheel firmly.
- Rotate the wheel (clockwise to raise, anticlockwise to lower) to adjust height to required setting, ensuring that the bolt holes are aligned, as in figure 2
- Release center pad, but continue to hold wheel securely
- Re-secure the 2 upright bolts, nuts and washers
- Check all bolts on the gantry are sufficiently secure by ensuring all spring washers are fully depressed

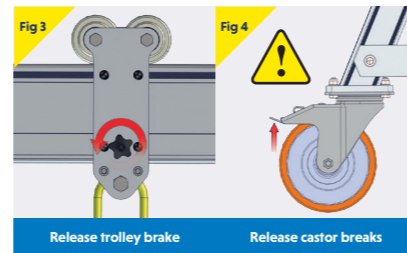
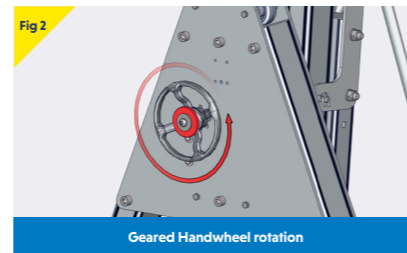
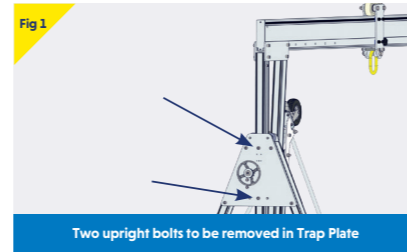

## With Ratchet System

Two Person Operation Recommended – one on each A-Frame

Always wear gloves when using this item.

- Release Ratchet (Figure 4). Ensure the hook at the end of ratchet strap is positively engaged within the bottom hole of the A-frame upright (Figure 5)
- Ensure Castor brakes are engaged.
- Remove lower bolt on trap plate
- Tension ratchet strap to take the upright/beam weight
- Remove upper bolt on trap plate
- Operate ratchet to adjust height to required setting, ensuring that the bolt holes are aligned as in figure 6
- Re-insert upper bolt and nut/washer assembly
- Ease tensioned strap aside, re-insert lower bolt and secure.
- Repeat on the second A-Frame, ensuring that the gantry uprights are vertical, and the beam is horizontal
- Check all bolts on the gantry are sufficiently secure by ensuring all spring washers are fully depressed

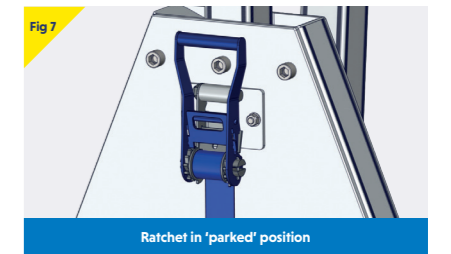
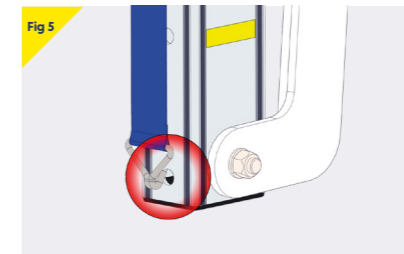
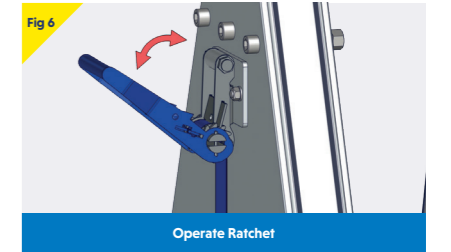
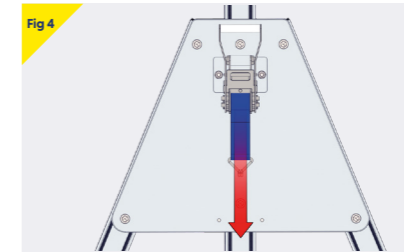

## ➤ Beam Height Adjustment

### Medium or Small A-Frame with no gearing fitted

Two person operation recommended – one on the bolts and one on the upright.

Always wear gloves when using this item.

- Ensure the castor brakes are engaged
- Adjust the upright position at one A-Frame by removing 2 x upright securing bolts and lifting from the strut handle, as in figure 1
- Re-insert bolts and nut/washer assembly's (do not over tighten)
- Repeat the height adjustment on the second A-Frame, ensuring that the gantry uprights are vertical, and the beam is horizontal
- Check all bolts on the gantry are sufficiently secure by ensuring all spring washers are fully depressed

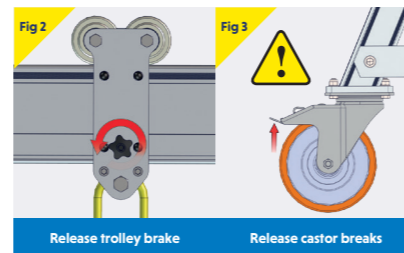
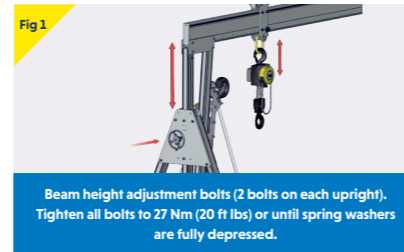

## ➤ Variants & Options

The list below outlines additional variants and options available;

- Stabiliser Leg
- Wind Up Jack Legs
- Ratchet Beam Elevation System
- Conversion to Winched Configurations
- Shackled Cheek Plates
- Customised Configurations

### Stabiliser Leg Configurations

Minimum Two Person Operation Recommended.

The centre of gravity is high on the intermediate (I) and tall (T) models and should have a Stabiliser Leg fitted to aid in its transportation. There are two safe modes of handling depending on the environment.

- The 'Stabiliser Leg' in Vertical Configuration is designed for use on flat, concrete or tarmac surfaces. This is the ideal mode for moving the A-Frame in a factory or depot environment.
- The 'Wheelbarrow' Configuration keeps the center of gravity of the A-Frame as low as possible and is designed for manoeuvring on rough ground and open areas

### Manoeuvring in Wheelbarrow Configuration

Two person operation recommended - Always wear gloves when using this item.

- Position the A-Frame on its back, with stabiliser leg on top.
- Ensure Castor brakes are engaged.
- Ensure Stabiliser Leg is correctly and safely assembled in the Wheelbarrow configuration
- Ensure pneumatic castor has its directional lock Engaged
- Rotate A-Frame onto its front so the Stabiliser Leg wheel is resting on the ground
- With a minimum of two people lift A-Frame using tie-bar (as shown in figure 3)
- Maneuver A-Frame in the same way as a wheelbarrow
- When 'parking' an A-Frame in this mode ensure pneumatic castor brake is engaged.



## Changing from Wheelbarrow to Vertical Configuration

Two Person Operation is Recommended - Always wear gloves when using this item.

- > To use the stabiliser leg in the vertical configuration, tall A-frames must be set to the lowest height setting and Intermediate A-frames must be set to one position from the lowest height setting.
- > With A-Frame on its back, unpin Wishbone Tie Bar from the Stabiliser Leg, as in figure 4 and 5
- > Unpin castor link plate from A-Frame Strut (as shown in figure 6 and 7), ensuring the weight of the Stabiliser Leg is held to help prevent the trapping of hands or fingers
- > Pivot Stabiliser Leg about Bolted Link Plate connection, insert Wishbone ends through A-Frame Tie-Bar holes and pin Wishbone with the 2 pins (as shown in figure 8 and 9)

## Changing from Vertical to Wheelbarrow Configuration

(Reverse of previous)

Two person operation is recommended - Always wear gloves when using this item.

- > With A-Frame on its back, unpin and remove Wishbone ends from Tie-Bar holes
- > Pivot Stabiliser Leg about the Bolted Link Plate connection
- > Pin Castor Link Plate onto A-Frame Strut, ensuring the weight of the Stabiliser Leg is held until securely pinned to help prevent trapping of hands or fingers
- > Pin Wishbone Tie Bar onto Stabiliser Leg

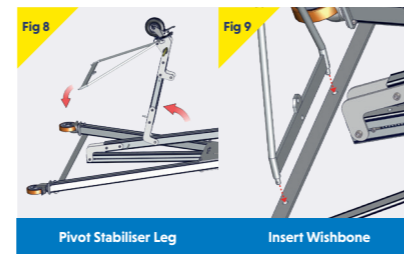
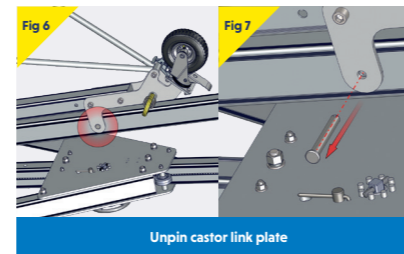
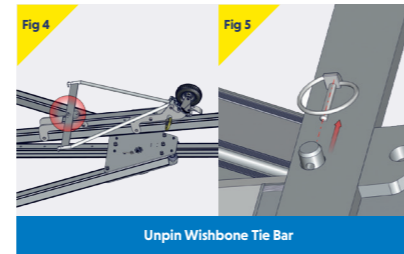

## Manoeuvring A-Frame in Vertical Configuration

One person operation recommended for manoeuvring - Always wear gloves when using this item.

- > With A-Frame on its back, as in figure 1, ensure A-Frame Castor Wheels brakes are engaged and they are locked in position. Put brakes on only with protective footwear. Do not use hands
- > Ensure Stabiliser Leg is correctly and safely assembled in the vertical configuration (see Changing from Wheelbarrow to Vertical Configuration)
- > Lift A-Frame into the vertical position about the A-Frame Castor Wheels (Two people are recommended for this action).
- > Continue to tilt the A-Frame past the vertical position until Stabiliser Leg Wheel takes the weight of the A-Frame
- > To manoeuvre A-Frame ensure the Stabiliser Castor has directional lock disengaged and release the brake on the A-Frame castors

- > When castor brakes are disengaged the A-Frame is easily manoeuvred by one person with one hand on the A-Frame leg and one hand on the stabilising leg strut (as in figure 2).
- > When "parking" the A-Frame in this mode, always apply a minimum of 2 castor brakes



## Wind Up Jack Leg Option (WUJL)

WUJL'S can be fitted to the gantry. This provides additional fine height adjustment (up to 250mm). Each foot may be adjusted independently providing a method of levelling the system on uneven ground.

If wind up jack legs are fitted the following points must be observed:

- Check whether the castors fitted are Load Rated or Pneumatic.

**N.B. For pneumatic (non load bearing) castors the WUJL system must always be applied prior to performing any lift. If load rated castors are fitted the operator can choose whether the castors or WUJL take the load on each foot of the gantry**

- When maneuvering the gantry, always have the jack legs in the 'parked' position as shown in figure 1.
- Position the gantry for the lift before setting the height with the jack
- Before lifting ensure all jacks are in the correct lifting position and are secured with locking pins and clips as shown in figure 2
- Manually raise each leg in turn and set the height by rotating jack handle clockwise

- Having set the adjustment of all four legs, ensure that the gantry uprights are vertical, and the beam is horizontal

## WUJL Inspection/Maintenance

The jack legs and brackets should be subjected to periodic inspections by a competent person in line with gantry inspection and maintenance guidelines (see page 8). It is recommended that when not in use the jack legs are removed and stored in a clean and dry manner. The jack leg should be lubricated with EP2 grease on the internal thread and gears, at regular intervals (up to 6 months maximum), depending on service conditions.

## Conversion to Winched Configuration

A Winch Kit and accessories can be supplied to convert the System into a winch capable system. Please contact your REID Representative for further details and requirements.

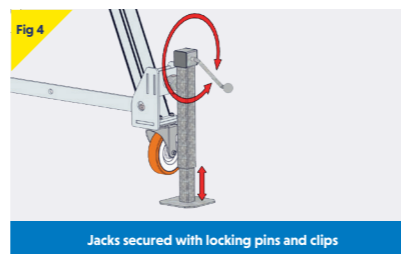
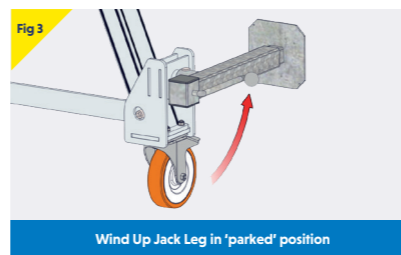

## Shackled Cheek Plates

The cheek plate with shackle pull point offers a mechanical aid to move the load along the beam in a control manner.

A chain block is required for this operation with a minimum capacity of 250kg.

## Notes for Correct Operation

- Ensure the chain block is attached to the shackle on the cheek plate, and on the master link of the trolley.
- The movement of the load should be from the center of the beam to the A-frame where the chain block is attached.
- The load chain will allow for the movement of the trolley, controlled by the operator using the hand chain on the block.

## Customised Configurations

For customised systems additional assembly and operation information may be provided as required.

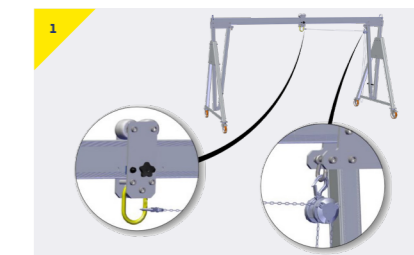

- Connect the chain block to the shackle on the cheek plate as shown
- Release the load chain until reaching the master link of the trolley, connecting the hook as shown



- Operate the chain block to move the trolley along the beam

## PORTAGANTRY™

- A** Beam length
- B** Beam adjustment
- C** Clear operating span
- D** Height to lifting eye
- E** Height increment
- F** Height to top of beam
- G** Width
- H** Height to top of roller

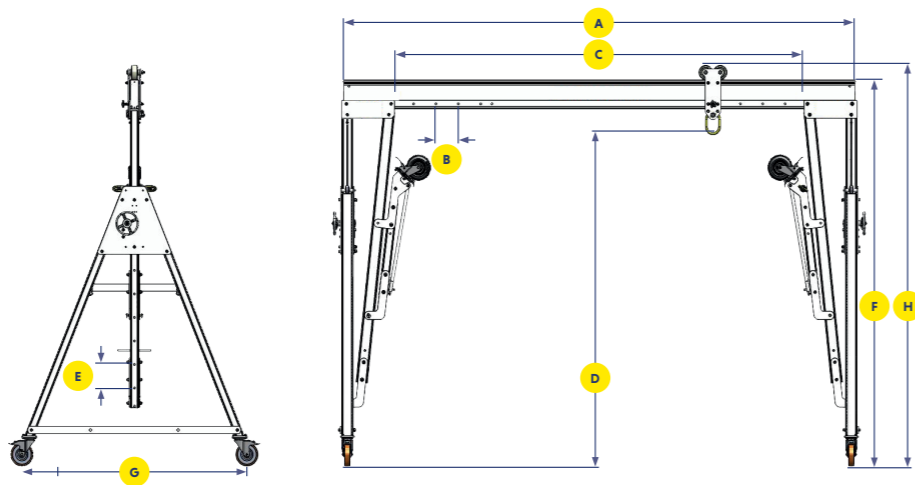

### Beam Height Adjustment

The height of each gantry beam is easily adjusted by the release of 2 bolts on each upright and can be easily and safely raised into position by increments of 200 or 150mm depending on product.

To assist with this activity a Geared Wheel or Ratchet system is provided for the larger gantries; manual on smaller frames.

### Beam Options (mm)

		Standard Beam Length A (mm) (Clear Operating Span C = A - 910 mm)							
		2500	3000	3920	4570	5500	6000	8400	9000
WLL Rating (kg)	A (mm)	2500	3000	3920	4570	5500	6000	8400	9000
	C min (mm)	1180	1680	2200	2050	2980	3480	5880	6480
	C max (mm)	1580	2080	3000	3650	4580	5080	7480	8080
	5000	39	47	61	71	85	x	x	x

### Weight of Beams [kg]

To ensure stability of the structure, the operating span of the beam must be equal to or greater than the distance between the castors on the A-frame

### Dimensions [mm]

Frame size [Product Code]	DMax Height to lifting eye	E Height increment	DMin Height to lifting eye	FMax Height to top of beam	HMax Height to top of roller	HMin Height to top of roller	G Width	A-Frame weight (kg) (approx)	Trolley roller size	Castor Diam	
	PGAS05000I	3181	5 x 200	G	2181	3592	3717	2717	1736	104*	125
PGAS05000T	4049	6 x 200	G	2849	4487	4612	3412	2021	114*	125	200
PGAS05000TC4	4500	6 x 200	G	3300	4938	5062	3862	2234	101	125	200
PGAS05000TC3	5000	6 x 200	G	3800	5438	5562	4362	2557	106	125	200
PGAS05000IR	3181	5 x 200	R	2181	3592	3717	2717	1736	99*	125	200
PGAS05000TR	4049	6 x 200	R	2849	4487	4612	3412	2021	109*	125	200
PGAS05000TC4R	4500	6 x 200	R	3300	4938	5062	3862	2234	96	125	200
PGAS05000TC3R	5000	6 x 200	R	3800	5438	5562	4362	2557	101	125	200

Dimensions use standard Master Link Trolley, other options available to increase resulting height of lift (HoL) and to assist with load movement. \*Weight includes stabiliser legs.

## Regulations, Standards & Directives

This product complies with the following:

- › ATEX Directive - 2014/34/EU
- › Machinery Directive 2006/42/EC
- › PPE Regulation (EU) 2016/425
- › The Provision and Use of Work Equipment Regulations 1998 (S.I. 1998 No. 2306)
- › The Lifting Operations and Lifting Equipment Regulations 1998 (S.I. 1998 No. 2307)
- › In conformity with EN795:2012, AS/NZS 5532:2013 and PD CEN/TS 16415:2013

It is essential to adhere to the safety regulations of the respective country for using manual lifting equipment.

## Accreditations

Quality and safety are key themes throughout this document and the REID Lifting ethos. It is with this in mind that we have undertaken external accreditations to ensure we stay focused on what is important to our clients and users, and ahead of market trends and developments.

REID Lifting is continuously audited by Lloyds Register Quality Assurance (LRQA) for approval of its Integrated Management System combining quality systems management, environmental issues and the health and safety practices within the company.

- › ISO 9001:2015 - Specifies requirements for a quality management system for any organization that needs to demonstrate its ability to consistently provide products that meet customer and applicable regulatory requirements and aims to enhance customer satisfaction.
- › ISO 14001:2015 - Specifies the requirements for implementing environmental management systems throughout all areas of the company.
- › ISO 45001 – Health & Safety Management System

- › LEEA Membership - REID Lifting is a full member of the Lifting Equipment Engineers Association (LEEa membership 000897). REID Lifting conforms to the main aims of the association which is to achieve the highest standards of quality and integrity in the operations of members. Entry qualifications are demanding and strictly enforced through technical audits based on the Technical Requirements for Members.

- › IRATA - REID Lifting is an associate member of the Industrial Rope Access Trade Association (IRATA International membership number 148). REID Lifting works in accordance with the IRATA Code of Practice, by doing so, contributes to promote the development of safe systems.

## Conformité Européenne [CE] & UK Conformity Assessed [UKCA]

REID Lifting's products have been designed, tested and approved (as appropriate) by the Conformité Européenne and UK Conformity Assessed. This certifies that REID Lifting's products meet the demands of the European and UK Directives and Regulations regarding Health and Safety requirements. The EC type-examination for this device has been carried out by SGS United Kingdom Ltd, 202b, Worle Parkway, Westonsuper-Mare, BS22 6WA, United Kingdom (CE body no.0120) in accordance with Module B of the PPE Regulation. The EC quality assurance system for this device has been carried out by SGS Fimko Oy, Takomotie 8, FI-00380 Helsinki, Finland. (CE body no. 0598) and SGS United Kingdom Ltd, 202b, Worle Parkway, Weston-super-Mare, BS22 6WA, United Kingdom (CE body no.0120) in accordance with Module D PPE Regulation (EU) 2016/425 and as brought into UK law and amended.

## The Queen's Award for Enterprise

REID Lifting has been awarded this prestigious award on four occasions for design, development and sale of lightweight, portable and safe lifting solutions.

- › Innovation category 2006 and 2013
- › International Trade 2013 and 2018

## Testing

Testing and technical file review are integral parts of our design and manufacturing process. External verification of products is undertaken where appropriate, using government approved Notified Bodies.

All products have been thoroughly type tested. Each product is supplied with a certificate of conformance and individual record of thorough examination or test.

## Language

It is essential for the safety of the user that if this product is re-sold outside of the original country of destination, the reseller shall provide instructions for use, maintenance, inspection and repair in the language of the country where it will be used.

## Product IPR

Intellectual property rights apply to all REID Lifting Ltd products. There are patents in place, or pending, for:

PORTAGANTRY<sup>®</sup> | PORTAGANTRY<sup>RAPIDE</sup><sup>®</sup> | PORTA<sup>DAVIT</sup><sup>QUANTUM</sup> | T<sup>DAVIT</sup><sup>®</sup>

All product names are trademarks of REID Lifting Ltd:

PORTAGANTRY<sup>®</sup> | PORTAGANTRY<sup>RAPIDE</sup><sup>®</sup> | PORTA<sup>DAVIT</sup><sup>®</sup> | PORTA<sup>BASE</sup><sup>®</sup> | T<sup>DAVIT</sup><sup>®</sup> | PORTA<sup>QUAD</sup><sup>®</sup>

## Safety Labels



Insert and secure the bolt before loading the system.



Insert the detent pin and fully engage before loading the system.



Insert the clevis pin and secure with the clip before loading the system.



Restraint point only.



Read the operational manuals before using the system.



Ensure the pin is fully engaged.

## Serial Labels

1. Product Number
2. Serial Number
3. WLL
4. Year of Manufacture
5. Standards
6. ATEX
7. Max Moment



The system is not suitable for fall arrest applications.



The system is suitable for fall arrest applications. Specify number of users. Max weight of 150kg.

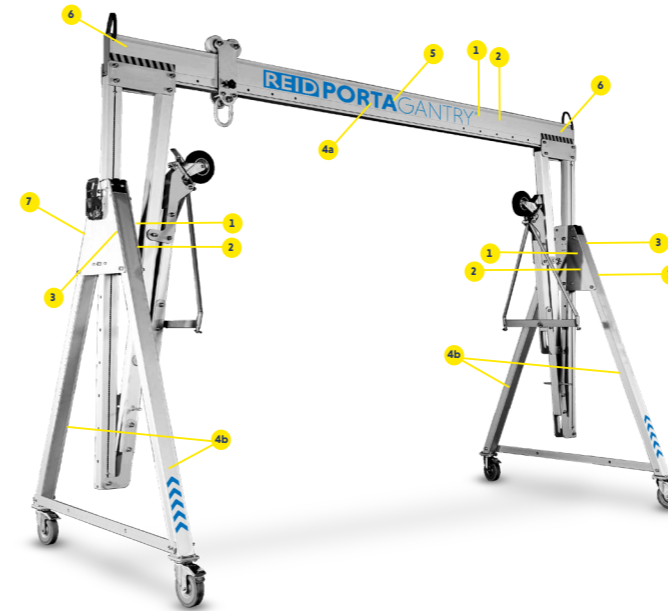

## Product labelling

The following labels must be present on your system and must be legible.

1

2

3

4

# REIDPORTAGANTRY®

5

## 5000KG

6

7



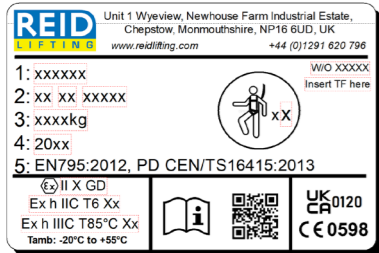

**Marking**

The serial labels indicate:

- > The product identification number
- > The product's unique serial number
- > The goods' capacity (WLL) of the device
- > The year of manufacture
- > The standards to which the device is approved
- > The ATEX rating of the product (if applicable)
- > CE Marking
- > Minimum braking load (MBL)

Insert data from serial numbers found on product into table here:

---



---



---



---



---



---



---



---

**Periodic Examination & Repair History**

Date	Inspected by	Pass/Fail	Corrective Action	Comments

---

---

---

---

---

---

---

---

---

---

---

---

---

---

---

---

---

---

---

---

---

---

---

---

---

---

---

---

---

---

---

---

---

---

---

---

---

---

---

---

---

---

---

---

---

---

---

---

---

---

# Contact Us

## Head Office, UK

Unit 1 Wyeview  
Newhouse Farm Industrial Estate  
Chepstow  
Monmouthshire  
NP16 6UD  
United Kingdom

-  +44 (0)1291 620 796
-  [enquiries@reidlifting.com](mailto:enquiries@reidlifting.com)
-  [www.reidlifting.com](http://www.reidlifting.com)

All information herein is copyright protected by REID Lifting Ltd. All company and product names are Trade Mark and Trade Name protected and all REID Lifting Ltd. Product IPR is protected under Patents, Patents Pending and/or Design Rights.



Printed using environment friendly processes and materials.